

TS40

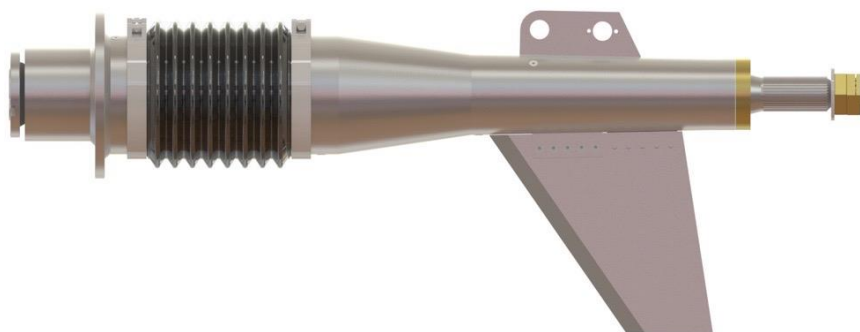

Description

Top System is a surface drive system trimmable and steerable. The Top System Surface Drive is suitable to planing motor boats of high performances with a range of features so far out of reach, which goes from 300 up to 4000 hp. The Top System transmission system is made entirely of AISI 316 stainless steel.

Accessories

- drives
- hydraulic kit
- cardan joint
- autopilot interface
- monitoring solution

Technical Data

<i>Model</i>	<i>TS40</i>
<i>Light Duty - Max Torque [Nm]</i>	<i>1.400 Nm</i>
<i>Heavy Duty - Max Torque [Nm]</i>	<i>1.000 Nm</i>

TS40

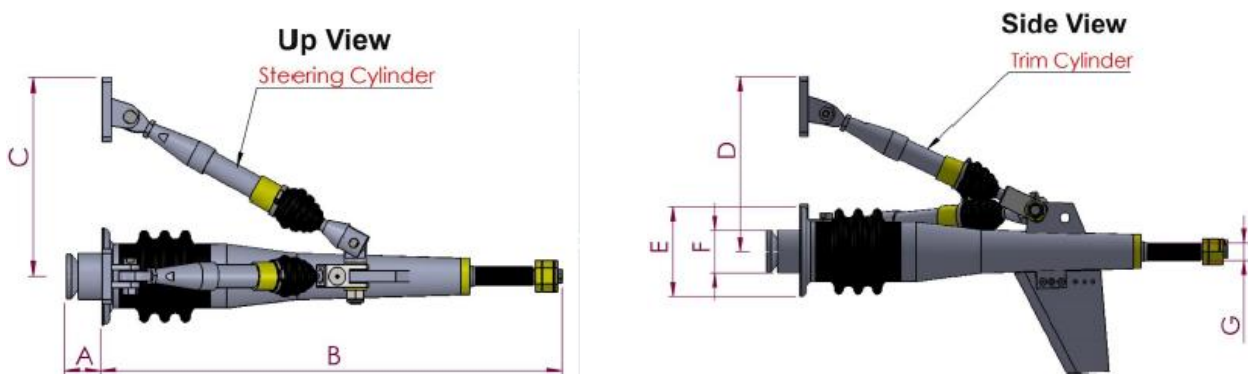

<i>Dimensions</i>			
<i>A</i>	<i>80 mm</i>	<i>E</i>	<i>Ø 210 mm</i>
<i>B</i>	<i>1000 mm</i>	<i>F</i>	<i>Ø 100 mm</i>
<i>C</i>	<i>330 mm</i>	<i>G</i>	<i>Z 19</i>
<i>D</i>	<i>410mm</i>	<i>Weight</i>	<i>120 Kg</i>

EasySet



Functions:

- *control of trim tabs and shaft trimming*
- *steering assistance*
- *roll stabilization*
- *steering limitation at high speed*
- *maneuvering assistance*
- *shaft parking*
- *engine data monitoring*